

HOW TO INSTALL ROLLER BLINDS

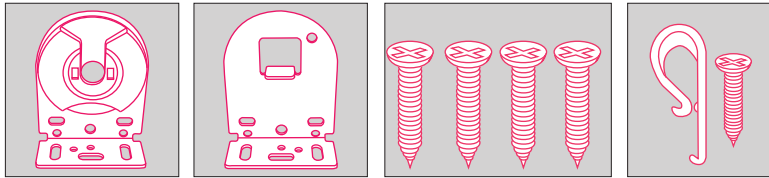

Items Checklist

- Roller Blind
- Pin End & Chain Drive Bracket
- 2 screws per bracket
- P Clips

Tools Required

- Cordless Drill with Philips head drill bit
- Metal Tape Measure

The screws provided must be secured into wooden window frames or wall studs. If you intend on installing into plaster, concrete, stone, brick or tile you require the appropriate plugs/wall anchors.

It is important these plugs/wall anchors are suitable for the weight of your blind.

If you are unsure, please contact us so we can advise a solution.

PLASTER	TIMBER	CONCRETE, STONE, BRICK or TILE
We recommend the use of the Ramset 10mm Grip Hollow Wall Anchor	Pre-drill holes and use the included screws	Use a masonry drill and appropriate plugs, anchors or screws

Brackets

There are two brackets provided per blind. One bracket is the Chain Drive bracket and the other is the Pin End Bracket.

The *Chain Drive Bracket* goes to the side that has the operating chain. So as per your order place the Chain Drive Bracket on the left, or the right where you have nominated the chain control mechanism to be.

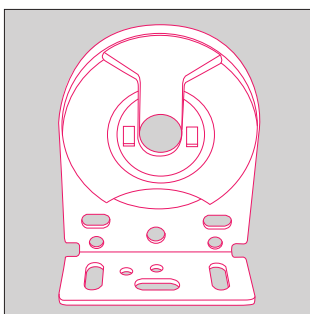

Pin End Bracket

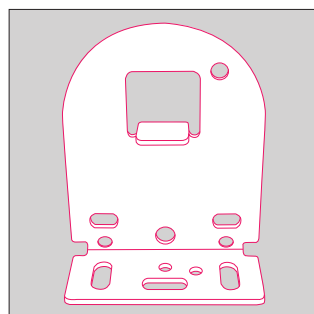

Chain Drive Bracket

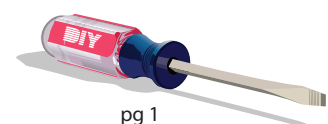
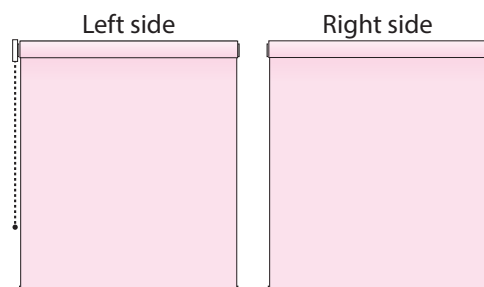

ROLLER BLINDS INSTALLATION

1. Position

As per your order, determine where you blind is to be fitted

- a) RECESS FIT - Inside your window frame
- b) FACE FIT - on the window frame or wall

2. Installing Brackets

a) Place the *Chain Drive Bracket* in the desired location you wish to have the operating chain as per your order. Either on the left hand side, or right hand side. Mark if necessary and pre drill 2 holes. After drilling holes, secure the bracket with screws. Wood screws have been provided, however screws suitable for gyprock or brick walls may need to be purchased. Refer to our table above to determine the appropriate drills and drill bits.

b) Repeat the process for the *Pin End Bracket*.

HANDY TIP: Use the edges of your architrave as a reference point to keep the brackets level

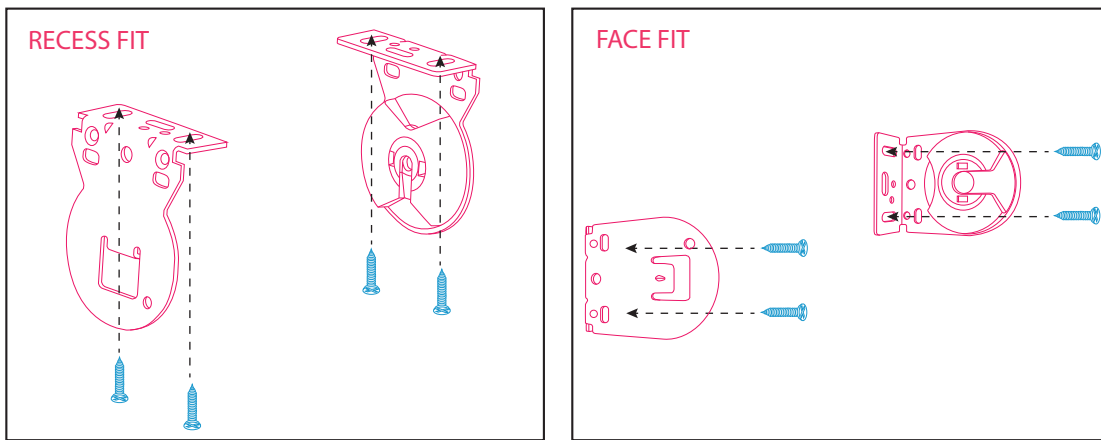

3. Positioning The Blind

a) Insert the blind at the *Chain End Bracket* first. It is important to ensure that the section where the chain is covered by the bracket is aligned to the top. If this is not done correctly your blind will not operate properly, it may be hard to wind up and down and will be at risk of damage.

b) Slot the pin end of the blind into the *Pin End Bracket* and make sure it clicks safely into place.

HANDY TIP: For large blinds have a second person help hold the blind into position.

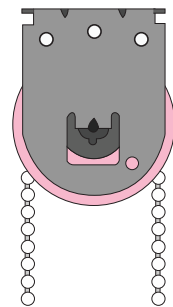
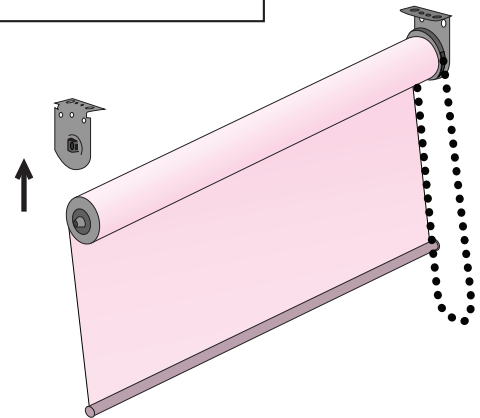

Ensure the tongue on the control bracket sits inside groove of the chain winder all the way

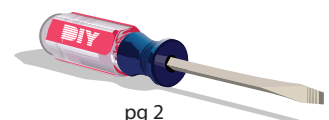

ROLLER BLINDS INSTALLATION

5. Child Safe Cord Tensioner

Australian Child Safety Laws state that a cord tensioner must be installed if the chain is less than 1.6m from the floor to prevent any risk of strangulation.

- a) Position the tension device at the bottom of the chain loop as shown below. It can be fitted to the inside of the window frame or in front of it.
- b) Install the tension device onto the frame, making sure that the loop chain hangs with minimal tension as illustrated below.

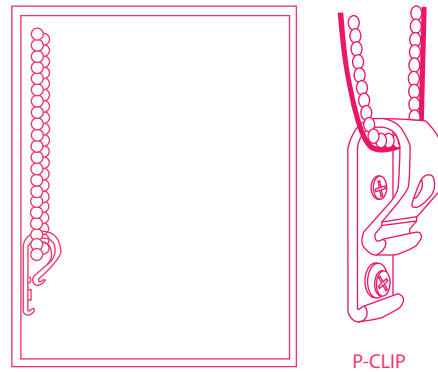

WARNING CHILD SAFETY WITH LOOPED CORDS, CHAINS & BEAD CORDS

Young children can strangle in the loop of pull cords, chain and bead cords, and cords that run through window coverings. They can also wrap cords around their necks. To avoid strangulation, keep cords out of the reach of young children. Also,

1. Install safety devices that remove the cord loop or reduce access to cords, and
2. Move cots and furniture away from window covering cords.

The tension device (P Clip) reduces the hazards of strangulation or entanglement by limited access to the cord or bead chain. Anchor the device with the cord or bead chain to the wall or floor so young children cannot pull the cord or bead chain around their necks. Always keep cords out of the reach of young children.

Handy Hints & Trouble Shooting

1. If your blind is hard to operate or making clunking noise and not rolling smoothly, it is likely that the positioning of the chain drive end of the blind, is in the incorrect position in the bracket. Please go back to the "Positioning of the Blind" section of the instructions and make sure that the end cap has not been slightly rotated out of position. The ACMEDA logo should always be in the 6 o'clock position.
2. For large blinds, have another person help you hold the blind, whilst placing it into the brackets
3. From time to time a blind can track off to one side, making it hard to wind up and risk the cloth/blind being damaged. This can easily be remedied by unrolling the blind and placing a 10cm piece of masking tape onto the aluminum tube on the side you want the blind to go to. Add a couple more thicknesses until the blind rolls up straight. If this does not fix the problem please contact us.
4. To maintain child safety laws, make sure to attach the P Clip and keep furniture and cots away from blind chains and cords.
5. Cleaning the blind only requires a damp cloth. Make sure not to rub the blind too hard when cleaning as you may damage the block out coating.
6. If the blind has a small curl or kink due to transport, please let the blind settle and this should fall out over time. Warm weather will usually rectify this. Blinds left in one position for long periods of time will result in the fabric holding a memory and forming a curve/kink to the cloth. This will drop out over time. Try to rotate the blind to different heights regularly to avoid this occurring.
7. If you decide that you would like to have the chain control on the opposite side to what you have ordered, simply remove the end caps and swap to opposite sides. You will also need to swap the bracket positions over.

5 Year
Warranty

www.diyonlineblinds.com.au

**Best Price
Guarantee 10%**
Or we'll beat it by
www.diyonlineblinds.com.au

**Australian
Made &
Owned** 
www.diyonlineblinds.com.au

For further information please contact our dedicated customer service team between Monday to Friday 9AM to 9PM or Saturday to Sunday 10AM to 5PM.

Phone: 1300 918 390 **Email:** sales@diyonlineblinds.com.au

