

HOW TO INSTALL ROMAN BLINDS | CORDED

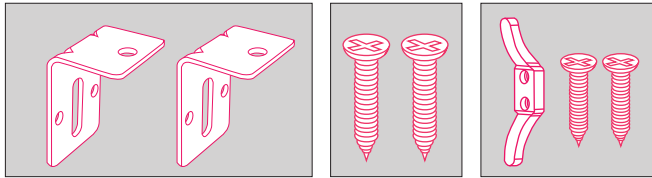

Items Checklist

- Roman Blind
- Brackets
- 2 screws per bracket
- Cleat to tie off cords

Tools Required

- Cordless Drill with Philips head drill bit
- Metal Tape Measure

The screws provided must be secured into wooden window frames or wall studs. If you intend on installing into plaster, concrete, stone, brick or tile you require the appropriate plugs/wall anchors.

It is important these plugs/wall anchors are suitable for the weight of your blind.

If you are unsure, please contact us so we can advise a solution.

PLASTER	TIMBER	CONCRETE, STONE, BRICK or TILE
We recommend the use of the Ramset 10mm Grip Hollow Wall Anchor	Pre-drill holes and use the included screws	Use a masonry drill and appropriate plugs, anchors or screws

ROMAN BLINDS INSTALLATION | CORDED

1. Installing The Brackets

- The installation brackets are to be fixed directly to the window frame or wall, spaced evenly. If you have allowed for your blind to be mounted above the window frame, install the bracket 20mm below the height you originally measured to accommodate for the blind head rail.
- The bracket needs to be installed with the longer edge to the wall.
- If possible, mount the first bracket between the control mechanism and the first draw cord for maximum support.
- Mark if necessary and pre drill 1 hole per bracket (use the central hole in the bracket as it will allow for minor adjustments up and down). After drilling holes, secure the brackets with the screws included (Wood screws have been provided, however screws suitable for gyprock or brick walls need to be purchased - refer to our table above).

Fixing a screw into the central hole will allow you to make minor adjustments by sliding up or down until you reach the right height level.

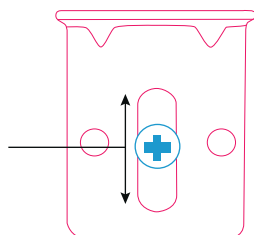

Bracket needs to be fixed with the longer edge to the wall or architrave (as per this image).

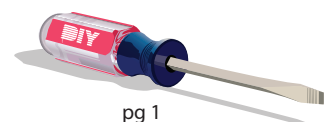
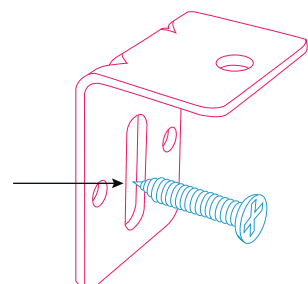

1. Installing The Brackets

e) Make sure all brackets are level.

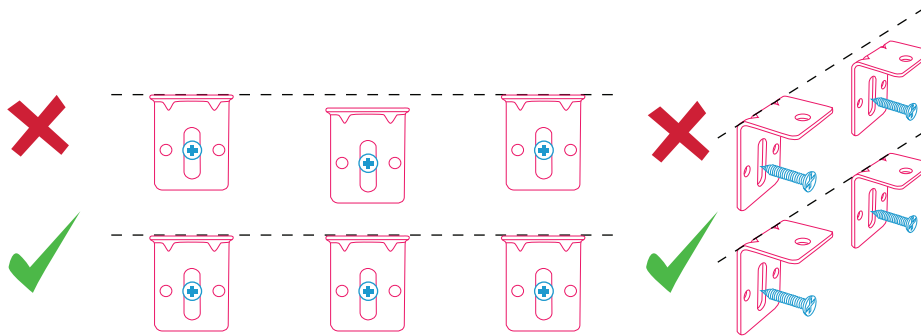

HANDY TIP: Make sure your hands are clean and dry before touching the blind.

2. Positioning The Blind

- a) Care must be taken when lifting the Roman Blinds. Ensure that the head rail is fully supported at all times and that all brackets are in place before positioning.
- b) Position the blind so it's sitting evenly on top of the brackets and central to the window
- c) Whilst holding the head rail in place, start from the central bracket and drill a screw upwards through the bracket directly into the head rail. Repeat for all brackets.

HANDY TIP: If installing Roman Blinds side by side, ensure there is a 10mm gap between the blinds.

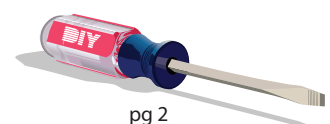
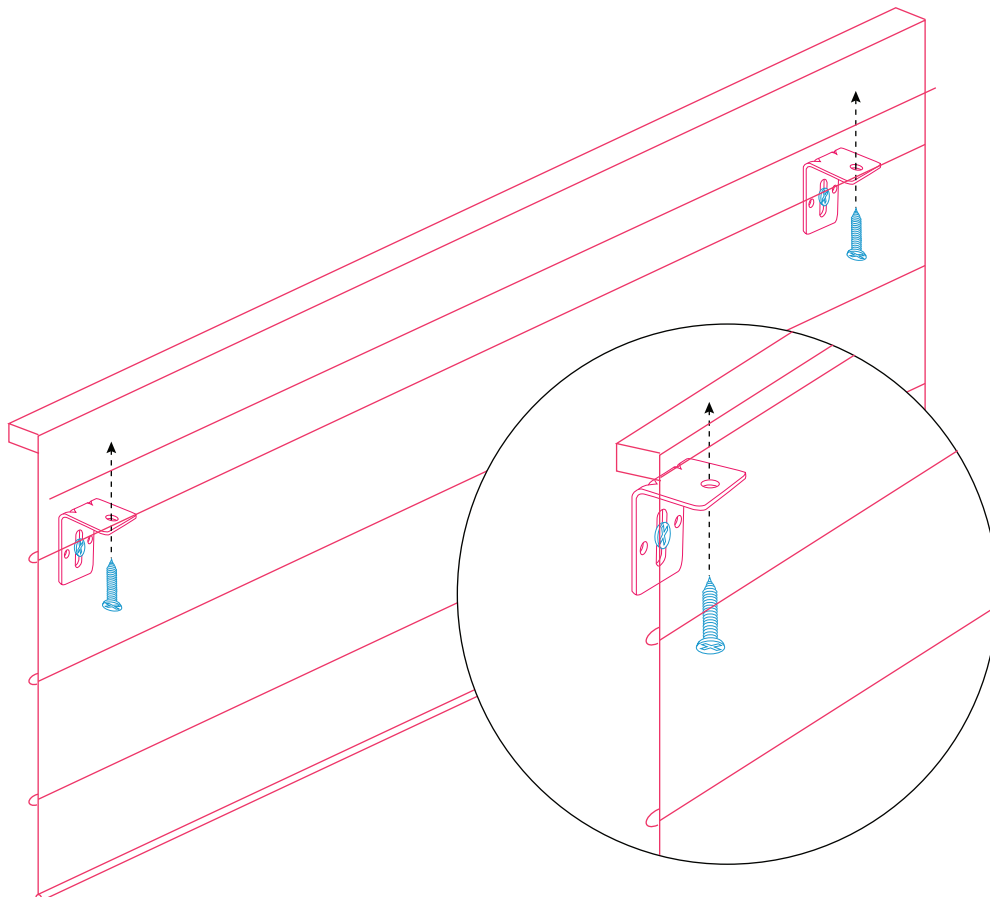

3. Install The Cord Cleat

Cord cleats must be installed to comply with Child Safety Regulations and more importantly keep kids safe from possible strangulation.

- a) The cleats must be installed at least 1600mm above floor level, because a child is capable of unwinding a cord from a cleat.
- b) Fasten the cleats to the wall using the screws provided. Do not use tape or glue.
- b) The cord must not form a loop longer than 220mm, and should be wound entirely around the cleat.

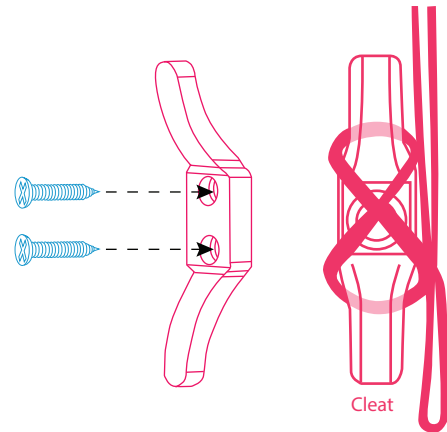

WARNING IMPORTANT FOR CHILD SAFETY - INSTALLING THE CORD CLEAT

Young children can strangle in the loop of pull cords, chain and bead cords, and cords that run through window coverings. They can also wrap cords around their necks. To avoid strangulation, keep cords out of the reach of young children. Also,

1. Install safety devices that remove the cord loop or reduce access to cords, and
2. Move cots and furniture away from window covering cords.

The tension device reduces the hazards of strangulation or entanglement by limited access to the cord or bead chain. Anchor the device with the cord or bead chain to the wall or floor so young children cannot pull the cord or bead chain around their necks. Always keep cords out of the reach of young children.

WARNING REGARDING CLEATS: Cleats should be mounted at a sufficient height, so as to keep cords out of reach of young children. Cords must be fully wrapped around the cleat at all times. Always keep out of the reach of young children.

WARNING FOR CORD RELEASE DEVICE: This cord release device reduces the strangulation hazard in the pull cord by removing the permanent loop. The cords should not be tied together and the cords should not be twisted around each other when the device is assembled. This device will not prevent strangulation if young children wrap pull cords around their necks. Always keep cords out of reach of young children.

Handy Hints & Trouble Shooting

1. Always get someone to help with larger blinds as they may be dangerous to lift when working at heights and you don't want to damage them.
2. Always follow the child safety information and remember it's the law in Australia to install child safety P-clips correctly.
3. If your blinds get dirty it's usually OK to clean them with a damp cloth.
4. Sometimes during transport your blind fabric might get a small kink or curl. Don't panic, once installed the weight of the blind will straighten this out. Warm weather will also help this.

5 Year
Warranty
www.diyonlineblinds.com.au

Best Price
Guarantee **10%**
Or we'll beat it by
www.diyonlineblinds.com.au

Australian
Made &
Owned 
www.diyonlineblinds.com.au

For further information please contact our dedicated customer service team between Monday to Friday 9AM to 9PM or Saturday to Sunday 10AM to 5PM.

